

RCA

DVD Player User's Guide

Model DRC233N

Changing entertainment. Again.



WARNING
RISK OF ELECTRIC SHOCK.
DO NOT OPEN.



This symbol indicates "dangerous voltage" inside the product that presents a risk of electric shock or personal injury.



This symbol indicates important instructions accompanying the product

To reduce risk of electrical shock, do not remove cover or back (no user serviceable parts inside). Refer servicing to qualified personnel.

WARNING To reduce the risk of fire or shock hazard, do not expose this DVD player to rain or moisture. No objects filled with liquids, such as vases, shall be placed on the apparatus.

CAUTION

THIS PRODUCT UTILIZES A LASER. USE OF CONTROLS OR ADJUSTMENTS OR PERFORMANCE OF PROCEDURES OTHER THAN THOSE SPECIFIED HEREIN MAY RESULT IN HAZARDOUS RADIATION EXPOSURE. DO NOT OPEN COVERS AND DO NOT REPAIR YOURSELF. REFER SERVICING TO QUALIFIED PERSONNEL.

CAUTION

FCC Regulations state that unauthorized changes or modifications to this equipment may void the user's authority to operate it.

FCC INFORMATION

This equipment has been tested and found to comply with the limits for a Class B digital device, pursuant to Part 15 of the FCC rules. These limits are designed to provide reasonable protection against harmful interference in a residential installation. This equipment generates, uses and can radiate radio frequency energy and, if not installed and used in accordance with the instructions, may cause harmful interference to radio communications. However, there is no guarantee that interference will not occur in a particular installation. If this equipment does cause harmful interference to radio or television reception, which can be determined by turning the equipment off and on, the user is encouraged to try to correct the interference by one or more of the following measures.

- Reorient or relocate the receiving antenna.
- Increase the separation between the equipment and receiver.
- Connect this equipment into an outlet on a circuit different from that to which the receiver is connected.
- Consult the dealer or an experienced radio/TV technician for help.

This class B digital apparatus meets all requirements of the Canadian Interference--Causing Equipment Regulations.

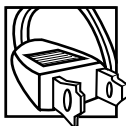

Refer to the identification/rating label located on the back panel of your product for its proper operating voltage.

Caution: To prevent electric shock, match wide blade of plug to wide slot, fully insert.

Attention: Pour éviter les chocs électriques, introduire la lame la plus large de la fiche dans la borne correspondante de la prise et pousser jusqu'au fond.

Product Registration: Please fill out the product registration card (packed separately), and return it immediately. For U.S. customers: Your RCA Consumer Electronics product may also be registered at www.rca.com/productregistration. Registering this product enables us to contact you if necessary.

Note:

This device is protected by U.S. patent numbers 4,631,603 and 4,577,216 and 4,819,098 and other intellectual property rights. The use of Macrovision's copy protection technology in the device must be authorized by Macrovision and is intended for home and other limited pay-per-view uses only, unless otherwise authorized in writing by Macrovision. Reverse engineering or disassembly is prohibited

This DVD player is designed and manufactured to respond to the Region Management Information. If the Region number of a DVD disc does not correspond to the Region number of this DVD player, this DVD player cannot play the disc. The Region number for this DVD player is Region No 1.

No objects filled with liquids, such as vases, shall be placed on the apparatus.

Keep your sales receipt to obtain warranty parts and service and for proof of purchase. Attach it here and record the serial and model numbers in case you need them. The numbers are located on the back of the player.

Model number: DRC233N Serial Number: _____

Purchase date: _____

Dealer address and phone: _____

CLASS 1
LASER
PRODUCT

Table Of Contents

Chapter 1: Setup and Connections

Things to consider before you connect	2
Install batteries in the remote control	2
Back of the DVD Player:	
Explanation of jacks and cables.....	3
Front of the DVD Player	5
Connect the DVD Player.....	6
Point the remote in the right direction and put it in DVD mode	8
Turn on the TV and the DVD player	8
Using different menus	8
How to find your TV's Video Input Channel	9

Chapter 2: The Remote Control

Button descriptions for DVD mode	10
Button description for TV and VCR modes.....	11
Using the remote to navigate through on-screen menus	11

Chapter 3: Playing Discs

Compatible Discs	12
Regional Coding	12
How to Load and Play a Disc	12
Search Options	13
Playback Options	13
Chapter Advance	13
Zoom	13
Scene Again	13
Using the On-Screen Info Displays.....	14
How to Navigate in the Info Display.....	15
Time Display	15
Title/Track Icon	15
Chapter Icon	15
Screen Fit Icon	15
Subtitles Icon.....	16
Audio Language Icon.....	16
Play Mode Icon	17
Bookmark Icon	19
Camera Angle Icon	20
Playing mp3, WMA, and/or JPEG Files.....	20
Musical Slide Show (playing JPEG files and mp3 files at the same time)	22

Chapter 4: DVD Menu System

The DVD Player Menu System	24
Play Menu	24
Play Mode menu.....	24
Standard Play.....	24
Random Play	24
Program Play	25
AutoPlay	25
IntroScan	25
Parental Control Menu	26
Locking your player	26
Unlocking your player.....	26
Changing your password	27
Explanation of Ratings Limits	27
Rated Titles	27
Unrated Titles	28
Display menu	28
TV Image	28
Front Display.....	30
Sound menu	30
Sound Logic.....	30
Virtual Surround.....	31
Languages menu.....	31
Player Menus	31
Disc Menu	31
Audio.....	31
Subtitles	31

Chapter 5: Additional Information

Troubleshooting	32
Maintenance of Cabinet.....	34
Handling Cautions	34
Progressive Scan.....	35
Progressive Scan Troubleshooting	36
Recommendations and information about discs	37
Limited Warranty	39
Accessories to complement your DVD player	41

This product incorporates copyright protection technology that is protected by method claims of certain U.S. patents and other intellectual property rights owned by Macrovision Corporation and other rights owners. Use of this copyright protection technology must be authorized by Macrovision Corporation, and is intended for home use only unless otherwise authorized by Macrovision Corporation. Reverse engineering or disassembly is prohibited.

Things to consider before you connect

Protect components from overheating

- Don't block ventilation holes on any of the components. Arrange the components so that air can circulate freely.
- Don't stack components.
- If you place components in a stand, make sure you allow adequate ventilation.
- If you connect an audio receiver or amplifier, place it on the top shelf.

Position cables properly to avoid audio interference

- Insert each cable firmly into the designated jack.
- If you place components above the TV, route all cables down the side of the back of the TV instead of straight down the middle of the back of the TV.
- If you have a TV antenna that uses 300-ohm twin lead cables, do not coil the cables. Also, keep the twin lead cables away from audio/video cables.

Note: Some discs may not be compatible due to laser pickup and disc design.

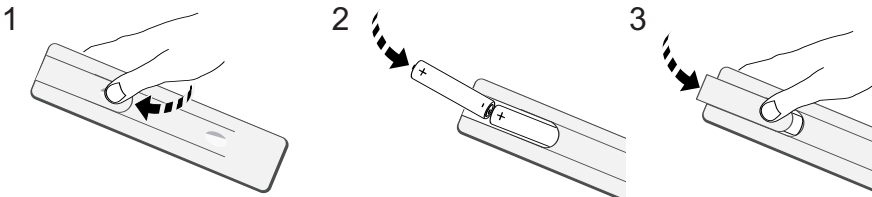

Install Batteries in the Remote

1. Remove the battery compartment cover.
2. Insert the batteries (provided), by matching the diagram in the battery compartment to make sure + and – are in the proper position.
3. Put the battery cover back in place.

Important Battery Information

- If you're not going to use the remote for a month or more, be sure to remove the batteries because they can leak and cause damage.
- Dispose of batteries in the proper manner, according to federal, state, and local regulations.
- Any battery may leak electrolyte if mixed with a different battery type, if inserted incorrectly, if all batteries are not replaced at the same time, if disposed of in fire, or if an attempt is made to charge a battery not intended to be recharged.
- Discard leaky batteries immediately. Leaking batteries can cause skin burns or other personal injury.

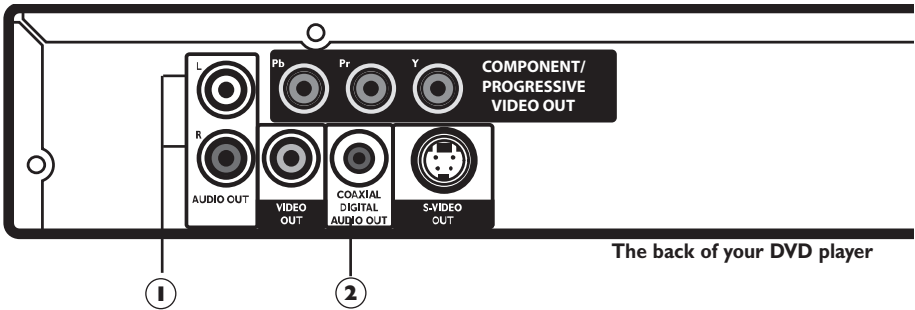

Back of the DVD Player

Explanation of Jacks and Cables

There are several ways to connect your DVD Player to your TV depending upon the cables you have and the jacks that are on the back of your TV. Different jacks and cables provide a different level of performance. The jacks on the back of your DVD Player and the cables used to connect them are explained below. A connection example and instructions are on pages 6 and 7.



AUDIO L and R jacks and cables



Audio Jacks and Cables

1 AUDIO L (left) and R (right)

These jacks send the audio from the disc you're playing to the TV. The audio jacks and cables are often color-coded (red for right audio, and white for left audio). You must connect audio cables to the AUDIO L and R jacks on the DVD Player and the corresponding Audio Input Jacks on the TV no matter which Video jack you connect (VIDEO; S-VIDEO; or Y, Pb, Pr).

If your component has only one input for audio (mono), connect it to the left (white L/Mono) audio jack on the TV and don't connect the right audio part of the cable.



2 COAXIAL DIGITAL AUDIO OUT



COAXIAL DIGITAL AUDIO OUT jack and cable

If you have a Dolby Digital or DTS audio/video receiver, connect a digital audio coaxial cable to the DVD Player's COAXIAL DIGITAL AUDIO OUT Jack and to the audio/video receiver's Digital Coaxial Input Jack.

Manufactured under license from Dolby Laboratories. "Dolby" and the double-D symbol are trademarks of Dolby Laboratories. Confidential unpublished works. © 1992-1997 Dolby Laboratories, Inc. All rights reserved.

DTS is a registered trademark of Digital Home Theater Systems, Inc.

Connections and Setup

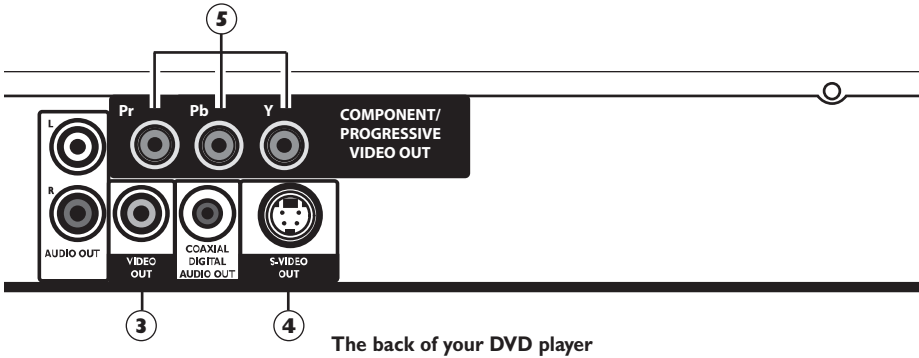

Video Jacks and Cables

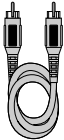

3 VIDEO OUT Jack and Cable

The basic Video jack (usually color-coded yellow) is also referred to as composite video. Composite video is better than the video quality you get from an RF coaxial cable (the type used to plug the cable feed into a TV). Usually the video cable is bundled with the audio cables (white and red).



4 S-VIDEO OUT Jack and Cable

The S-VIDEO OUT (separate video) jack provides better picture quality than composite video (the VIDEO OUT jack) because the color is kept separate from the black and white part of the video signal. If your TV has an S-Video jack, connect the DVD Player to the TV with an S-Video cable.

Note: Remember to connect the audio cables because the S-Video cable carries only the picture signal, not the sound.



5 COMPONENT VIDEO/PROGRESSIVE OUT (Y, Pb, Pr) Jacks and Component Video Cables

The Y, Pb, Pr jacks provide optimum picture quality because the video signal is separated into three parts.

To ensure maximum picture quality, use three video-grade cables (yellow) for the connection. You can also buy bundled component video cables that are color-coded to match the Y, Pb, Pr jacks (red, green, and blue).

Note: Remember to connect the audio cables because the component cable carries only the picture signal, not the sound.

Connections and Setup

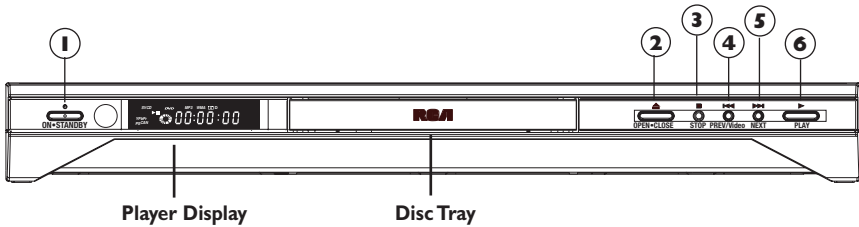

Front of the player

- ① **ON/STANDBY** - Turns the player on and off. The indicator light comes on when the player is in standby mode (off but still plugged into an AC outlet).
- ② **OPEN/CLOSE** - Opens and closes the disc tray.
- ③ **STOP** - Stops playing a disc.
- ④ **PREV/VIDEO** - During playback, goes to the beginning of the chapter (DVD) or track (CD), or to the beginning of the previous chapter or track.
When you're not playing a disc, accesses Video Output options when you press and hold the button for 3 seconds (page 35).
- ⑤ **NEXT** - Goes to the beginning of the next chapter or track.
- ⑥ **PLAY** - Plays a disc, and closes the disc tray if it is open.

Player display

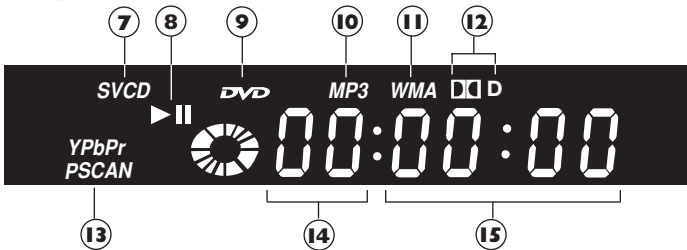

- ⑦ Shows the type of disc in the disc tray: Audio CD (**CD**), Video CD (**VCD**), Super Video CD (**SVCD**).
- ⑧ Playback status: Forward play (**▶**), reverse (**◀**) or pause on still frame (**||**).
- ⑨ **DVD** appears when DVD disc is loaded.
- ⑩ **MP3**: mp3 file is loaded.
- ⑪ **WMA**: WMA file is loaded.
- ⑫ **D D** appears if the disc being played has Dolby digital sound.
- ⑬ **YPbPr PSCAN**: appears when video is being output in progressive scan format. To change to interlace video format, press the PREV/VIDEO button (see page 35).
- ⑭ Chapter or track being played.
- ⑮ Time elapsed:
DVD: hour and minutes
Audio CD: minutes and seconds

Connections and Setup

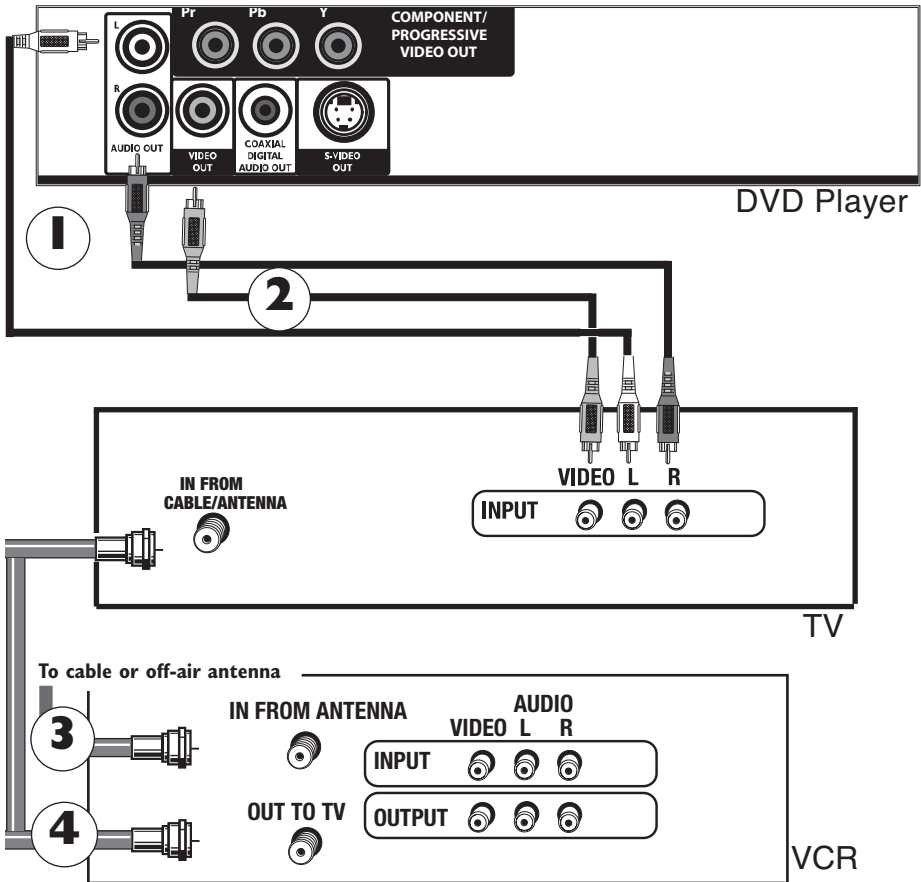

Connecting a VCR is optional. It is shown in this connection diagram since most households have a VCR connected to the TV.

Notes:

The back of your TV and VCR might look different than the ones pictured here. Details about the different kinds of cables used to connect your DVD player are on page 3.

Don't connect the DVD player to the VCR, or through the VCR. Doing so could negatively affect the picture quality and/or disable the DVD player.

For U.S. customers: If you prefer, we can provide you with the name of an Authorized Service Representative who will visit your home for a fee to install your electronic entertainment system and to instruct you in its operation. For details about this service, call 1-888-206-3359.

For additional assistance while using your RCA product, please visit www.rca.com/customersupport

Connection: DVD + TV + VCR

1. Connect the audio cables to the AUDIO OUT L (left – white) and R (right – red) jacks on the back of your DVD Player, and to the corresponding Audio Input jacks on your TV (sometimes labeled AUDIO INPUT L and R).

2. Connect the video cable.

Basic video connection – Connect the video cable (yellow) to the VIDEO OUT jack on the back of your DVD Player, and to the Video Input jack on your TV (sometimes labeled VIDEO INPUT).

Note: If your TV has an S-Video jack, connect the S-Video cable (not provided) to the S-VIDEO OUT jack on the back of your DVD Player and to the S-VIDEO jack on your TV.

– OR –

If your TV has component video jacks (Y, Pb, Pr), use video-grade cables (not provided) to connect the TV to the DVD player's COMPONENT VIDEO OUT (Y, Pb, Pr) jacks. It is essential to match the color coded connectors with a compatible TV.

If you have a Progressive Scan TV, you must use the Component Video connection (Y, Pb, Pr), and activate Progressive Scan by pressing the PREV/VIDEO button on the front of the DVD player (for instructions, go to page 35).

3. Connect the antenna or cable to the Antenna Input jack on the VCR (sometimes labeled IN FROM ANTENNA).

Note: Connecting a VCR is optional. It is shown in this connection diagram since most households have a VCR connected to the TV.

4. Connect a coaxial cable to the Antenna Output jack on the VCR (OUT TO TV) and to the Antenna Input jack (IN FROM CABLE/ANTENNA) on the TV.

5. Insert the AC power cord into an AC outlet.

Go to page 8

More Information about Progressive Scan

Some high-end HDTVs and multimedia monitors offer progressive scanning of the video signal instead of interlace. Proponents of Progressive Scan say it provides a crisper picture because it eliminates the “flicker” or “jitter” at the edges of the screen. Your DVD player is equipped to send a progressive scan signal, but you must connect the DVD player via the COMPONENT jacks (Y, Pb, Pr) to a Progressive Scan TV or monitor, AND you must activate Progressive Scan by pressing the PREV/VIDEO button on the front of the DVD player (for instructions, go to page 35).

Note: If your TV doesn't have Audio and Video Input Jacks and only has an RF jack, you need to connect an RF modulator (not provided). For information, go to page 41.

Connections and Setup

Point the Remote in the Right Direction and Put it in DVD Mode

When you want the remote to operate the DVD Player, point the remote at the DVD Player, **not** the TV. Make sure the remote is in DVD mode - press the DVD button. Also, you must make sure there is a clear path between the remote control and the DVD Player because the remote control uses infrared (IR) technology that sends a command from the remote control to the IR sensor on the front of the DVD player.

Turn on the TV and DVD Player

1. Turn on your DVD player. Turn on your TV and tune it to the correct Video Input Channel (if you don't know which channel is the Video Input channel, go to page 9 for help).

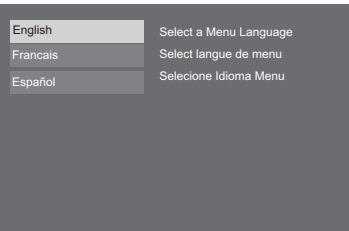

2. The first time you turn on your DVD player, a Language Selection menu appears. If you want the DVD player's menus to appear in *English*, press the OK button on the remote control. If you prefer another language, press the \blacktriangledown button until that language is highlighted, and press OK to select it.

Using Different Menus

Each disc is programmed with different features. There are three separate types of menus:

- **The Disc menu** – The Disc menu is part of each disc and is separate from the DVD player's menu. The contents of each Disc menu vary according to how the disc was authored and what features were included on the disc. To access the Disc Menu, press the MENU button on the remote control.
- **The DVD player's Info Display** – The Info Display appears as icons across the top of the screen. It can only be accessed while you are playing a disc—press the INFO button on the remote control.
- **The DVD player menu** – The DVD player's menu system is accessed only when a disc *isn't* playing. It appears automatically when you press the STOP button on the remote.

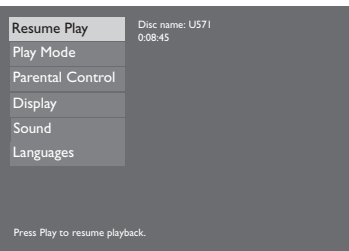
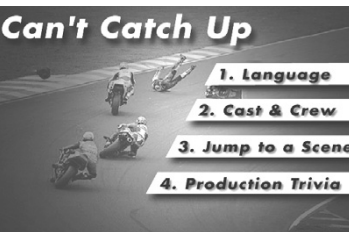

Remember: A feature will only work if the disc was programmed with that feature. For example, if you choose subtitles on the Info Display, the subtitles will only appear if the disc was created with subtitles. If a menu or icon is "grayed out" it means that item (or feature) isn't available.

How to find your TV's Video Input Channel

In order to see what's playing on your DVD Player, you need to tune the TV to the Video Input Channel that corresponds to the jacks you used to connect the DVD Player to the TV. The Video Input Channel(s) varies for different brands and different models of TVs. If your TV is an RCA, GE, or Proscan brand, the DVD's remote control probably operates it. Just press the TV button, and then press the INPUT button until you see the DVD's main menu, screen saver, or the disc you're playing. If your TV is another brand, check the list below for suggestions on how to access the TV's Video Input Channel:

Consult the instruction manual that came with your TV.

If you can't find the information in the manual, or can't find the manual, review the following list.

- You might select the Video Input Channel from the TV's on-screen menu system.
- Press the Channel up and/or down buttons on the TV's remote control (sometimes the Video Input Channel is stored in the TV's channel list).
- There might be a button on the TV's remote control or on the TV that accesses the Video Input Channel (see table below for examples).
- You might tune to it by pressing a specific channel number (see Channel Number in the table below).

Video Input Channel Variations				
Button/Switch on the TV	Button on the TV remote		Channel Number	
VIDEO	VIDI	S-VID	00	93
SIGNAL	LINE	INPUT	90	VID 1
VID 1	VID	SOURCE	91	VID 2
VID 2	VIDEO	AUX	92	INPUT

Next Steps

Before you start playing discs, you might want to get familiar with the remote control – **Chapter 2** has details. Playing Discs is found in **Chapter 3**; the menu system is outlined in **Chapter 4**; and **Chapter 5** contains troubleshooting, Limited Warranty, and accessory information.

Button Descriptions for DVD Mode

In addition to operating your DVD Player, the remote control that came with your DVD player will operate most RCA, GE, and Proscan TVs and VCRs. However, this page only describes the buttons on the remote that you will use with your DVD Player.

For descriptions of remote control buttons to be used with your TV and VCR (RCA, GE, and Proscan only), go to the next page.

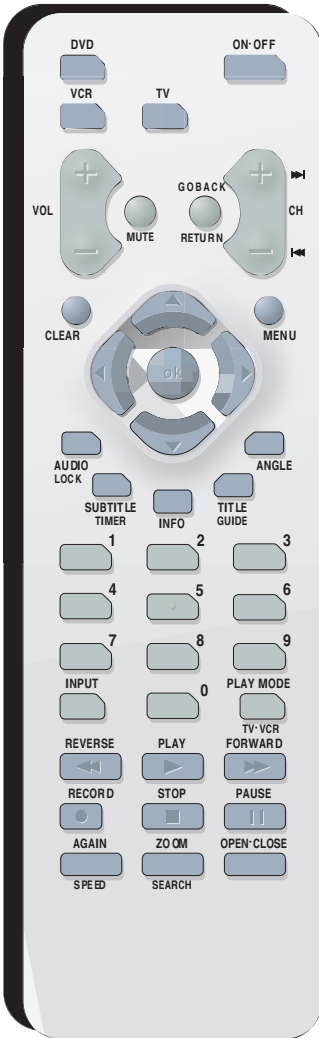

DVD function buttons listed alphabetically

- ▶▶ | ◀◀** Advances to the next/preceding chapter or track.
- 0-9** Use to input information such as chapter numbers, track numbers, or to make selections on some menu screens.
- AGAIN** Quick reverse (Scene Again™ feature) - replays the last 10 seconds (approximately) of a DVD movie.
- ANGLE** Accesses the Camera Angle icon in the DVD disc Info Display. Also used to rotate JPEG files 90°.
- AUDIO** Accesses the Audio icon in the Info Display that enables you to play a disc in a different language.
- CH+/-** Advances to the next/preceding chapter or track.
- CLEAR** Removes on-screen menus and displays.
- DVD** Puts the remote in DVD mode so it operates the DVD player.
- FORWARD** Searches forward through the disc.
- INFO** Displays the on-screen Info Display when you're playing discs.
- MENU** When playing a disc, displays the disc's menu.
- ON-OFF** Turns DVD player on and off.
- OK** Selects the setting or menu that is highlighted.
- OPEN-CLOSE** Opens and closes disc tray.
- PAUSE** Pauses disc play. With DVD discs, press two times to search frame by frame.
- PLAY** Begins disc play.
- PLAY MODE** Accesses Play Mode icon in the Info Display.
- RETURN** Goes back to the previous menu.
- REVERSE** Searches backward through the disc.
- STOP** Stops playback. Press and hold to open and close the disc tray. In order to see the DVD Player menu, press the STOP button.
- SUBTITLE** Accesses the Subtitle icon in the Info Display.
- TITLE** Accesses the DVD disc guide (if available).
- ZOOM** Enlarges the picture on the screen (DVD, VCD, and JPEG only).

Button descriptions for TV and VCR buttons

This remote operates most TVs and VCRs that carry the RCA, GE, or Proscan brand. The following list (in alphabetical order) provides basic information about how these buttons will operate when in TV or VCR mode.

CH +/-	In TV mode, changes channels.
GO BACK/RETURN	In TV mode, goes back to the last channel the TV was tuned to.
GUIDE	In TV mode, accesses the GUIDE Plus+ programming guide if the TV has that feature.
INPUT	In TV mode, tunes to the TV's Video Input Channel(s). For more information about Video Input Channels, go to page 9.
LOCK	In VCR mode, accesses the childlock feature if the VCR has one.
MUTE	Lowers the volume to minimum level. Press again to restore volume.
RECORD	In VCR mode, used to record a program.
SEARCH	In VCR mode, accesses Index search feature.
SPEED	In VCR mode, selects tape speed.
TIMER	In VCR mode, accesses the timer recording menu in some models.
TV	Puts the remote in TV mode so it operates the TV (RCA, GE, and Proscan TVs only).
TV•VCR	Functions as a TV/VCR button in VCR mode.
VCR	Puts the remote in VCR mode so it operates the VCR (RCA, GE, and Proscan VCRs only).
VOL <>	Decreases and increases volume level.

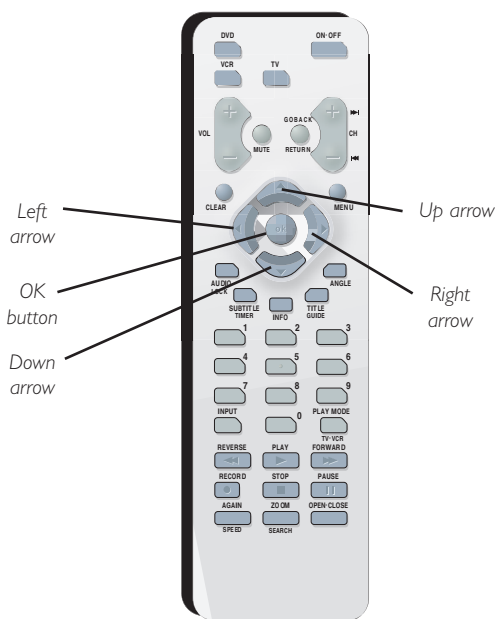

Using the remote to Navigate through On-Screen Menus

No matter what on-screen display you're using (the DVD player's menu, the Info Display that appears during playback, or a disc's menu), you'll use the same buttons on the remote control to navigate through the on-screen display: the four arrow buttons and the OK button.

Use the arrow buttons on the remote to move through on-screen menus in the direction of the arrow button (to move right, press the right arrow button; to move left, press the left arrow button, etc.). The arrow buttons are used to highlight an option. Once highlighted, press the OK button to select the option that is highlighted.

Use the arrow buttons to highlight on-screen options. Use the OK button to select an option that is highlighted.



Compatible discs

This DVD Player is capable of playing the following types of discs: DVDs, DVD+R, DVD+RW, DVD-R, DVD-RW, Audio CDs, CD-R, CD-RW, Video CDs (VCDs), SVCDs. CDs with mp3 files, WMA files (Windows Media Audio), and JPEG files on them. Before you put a disc in the player, make sure it is compatible.

You can't play the following types of discs: Laserdiscs, CD-I, CD-ROM (computer-only discs), DVD-ROM, discs recorded using other broadcast standards (i.e. PAL or SECAM), or CD-G discs.

Note: Some discs may not be compatible due to laser pickup and design.

Regional Coding

Both the DVD Player and the discs are coded by region. These regional codes must match in order for the disc to play. This player's code is **region 1**.

ALL means all regions. Other regions are: 2: Europe, the Middle East, Rep. of South Africa, Japan - 3: Southeast Asia, Taiwan - 4: Central America, South America, Australia, Mexico, New Zealand - 5: Russian Federation, Africa (except Egypt and Rep. of South Africa), India, Pakistan - 6: China.

How to load and play a disc

Turn on your DVD Player and your TV.

1. If necessary, tune the TV to its Video Input Channel (for help, go to page 9).
2. Press the OPEN/CLOSE button (the disc tray opens). Place a disc gently into the tray with the disc's label facing up (double-sided discs have content on both sides, so you can place the disc with either side up).
3. Press the OPEN/CLOSE or PLAY button. The disc tray closes. The DVD Player reads the disc's table of contents, and then one of three things happens depending on how the disc was programmed:
 - The disc starts playing.
 - The disc menu appears. One of the options will start playing the disc. Highlight that option and press OK.
 - The DVD Player's main menu appears (since the *Play* menu is already highlighted, just press the OK button).

Search Options

To search a disc, you can use the FORWARD button or the REVERSE button. You can also use the following search features:

Picture Scan - When you're playing a disc, each time you press FORWARD or REVERSE, your DVD Player scans the disc faster until you reach the fastest scan speed. To resume normal playback, press PLAY.

Freeze Frame and Frame Advance – While a disc is playing, press PAUSE to freeze the picture. To advance one frame at a time, press PAUSE again (the on-screen icon changes from PAUSE to FRAME). Each time you press the FORWARD or REVERSE button, the picture goes to the next (or previous) frame. To resume normal playback, press PLAY.

Note: If you pause a DVD disc or VCD disc for a long period of time, the video will disappear from the screen. Press any button on the remote to revert to the place on the disc where you paused playback.

Slow Motion (in Freeze Frame Mode) – While a disc is playing, press PAUSE. Press REVERSE or FORWARD (each time you press REVERSE or FORWARD the slow motion will get even slower until you reach the slowest speed). To resume normal playback, press PLAY.

Playback options

Many of your DVD Player's playback features are accessed through the Info Display, the banner at the top of the screen that appears during playback (for more information, go to page 14). Additionally, with some discs you can access playback features directly from the remote control.

Chapter Advance

While a disc is playing, you can skip forward or backward a chapter or track at a time by pressing the CH+ and/or CH- buttons—also labeled ►► and ◀◀

Zoom

1. While you're playing a disc, press ZOOM (the player zooms in on the image). Each time you press ZOOM, the picture is magnified even more (until you get to the maximum zoom level).
2. To see other parts of the picture when you've zoomed in on the image, try pressing the ▲, ▼, ◀ and ▶ buttons to go in corresponding directions. This feature is called pan and scan.

Scene Again™ (Quick Reverse)

While you're playing a DVD disc, press the AGAIN button on the remote (the disc automatically repeats the last several seconds of the movie).

Playing Discs

Using the On-Screen Info Displays

The Info Display appears across the top of the screen when you press the INFO button on the remote while you're playing a disc. Use the ◀ and ▶ buttons to highlight different icons. Once an icon is highlighted, follow the on-screen instructions, and use the ▲ or ▼ buttons on the remote control to scroll through the options.

You can only access the Info Display when you're playing a disc. Also, the Info Display features are only available if the disc was created with that particular feature. If one of the icons is "grayed out," that feature isn't available for the disc you're playing.



The invalid symbol appears on the screen when you press a button that doesn't have any function. To make the Info Display disappear from the screen, press INFO on the remote.

DVD Disc Info Display

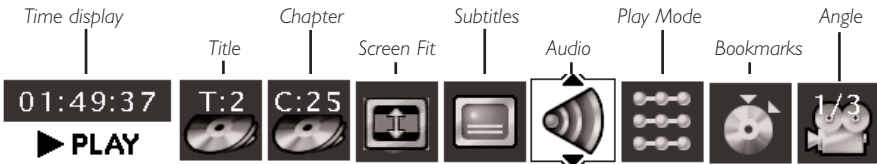

Audio CD Info Display

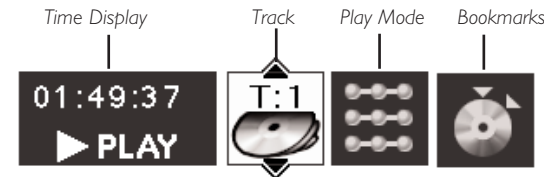

Video CD (VCD) Info Display

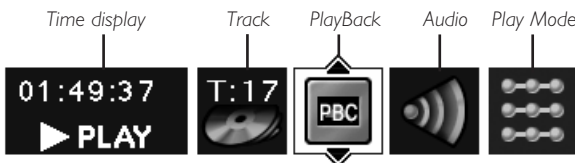

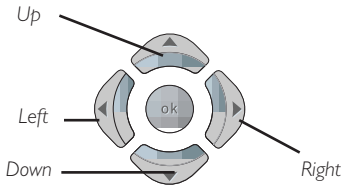

How to navigate the Info Display

To access the Info Display, press the INFO button on the remote while you're playing a disc.

Use the ◀ and ▶ arrow buttons on the remote to highlight different icons. Once an icon is highlighted, follow the on-screen instructions, and use the ▲ or ▼ buttons to scroll through options.

01:49:37

Time Display (all Info Displays)

This feature displays the time that has elapsed during playback. For DVD discs, the time displayed refers to the current title and acts as a Time Search feature. You can skip to any scene.

Highlight the Time Display, and use the number buttons on the remote to enter the elapsed time you want to go to. You must use two digits for each field. For example, if you enter 01:35:12, playback will start 1 hour, 35 minutes, and 12 seconds into the title.

Note: For Audio CDs, the time displayed refers to the track that's playing.



Title/Track Icon (all Info Displays)

Some DVD discs contain more than one title. Each title is divided into chapters. CDs are divided into separate tracks. To select a title/track:

After you highlight the Title/Track icon, use the number button(s) on the remote to enter the title number (track number), or press the ▲ or ▼ buttons to scroll through the titles/tracks.

Note: Many discs only have one title.



Chapter Icon (DVD Info Display)

A title can be divided into individual chapters (similar to tracks on a CD). To skip to a specific chapter:

After you highlight the Chapter icon, use the ▲ or ▼ buttons to scroll through different chapters. You can also use the number buttons on the remote to enter a chapter number.

Note: The Chapter feature won't work if the disc isn't formatted with separate chapters.



Screen Fit Icon (DVD Info Display)

You can change the way the image appears on the screen when you're playing a DVD movie by using the screen fit icon.

After you highlight the Screen Fit icon, press the ▲ or ▼ buttons to choose between *Normal*, *Enhanced*, and *Maximum*.



Subtitles Icon (DVD Info Display)

By default, subtitles are off. To turn subtitles on:

1. With Info Display on the screen, press the ► button until the Subtitle icon is highlighted.
2. To turn subtitles on or change the language, press the ▲ or ▼ button repeatedly to see what settings are available (the options appear in the box at the bottom of the Info Display).
3. To turn subtitles off, follow the steps above until *Subtitles Off* appears.

Notes:

Changing the subtitle language with the Info Display will only affect the disc you are currently playing. When the disc is removed or the player is turned off, the subtitle language will revert to the language setting specified through the DVD player's main menu.

If the disc doesn't contain the language you select, the disc's default language is automatically selected.

Some discs are programmed to only allow access to the subtitle feature through the disc's menu. To access the disc's menu, press the MENU button.

To make the Info Display appear, press the INFO button on the remote.



Audio Language Icon (DVD Info Display)

If the disc was created with different language tracks (recorded in different languages), you can change the language while you're playing the disc.

1. While a disc is playing, press INFO (the Info Display appears).
2. Press the ► button until the Audio icon is highlighted.
3. Press the ▲ button on the remote to scroll through the available audio languages (the dialog plays in the language you selected).

If that doesn't work, try selecting the language via the disc's menu (press the MENU button on the remote).

Notes:

The language feature only works if the disc was created with multiple language tracks. If the disc doesn't contain the language you selected, the disc plays in the default language.

When you choose an audio language during playback, you only override the audio language setting in the DVD Player's main menu temporarily.

The audio language can also be changed through the DVD player menu.

Some discs may require that you choose the language through the disc's menu.

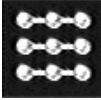

Play Mode Icon (DVD, CD, Info Displays)

The Play Mode options available depend upon the type of disc you're playing. The default play mode (standard play) plays the disc's contents in the order in which the disc was created (i.e., track 1 plays first, followed by track 2, etc.).

Play Mode Options

Repeat: DVDs, Audio CDs, VCDs, S-VCDs, mp3 and WMA.

Random Play: Audio CDs (tracks play in random order); mp3; WMA.

Program Play: Audio CDs, DVDs, mp3, WMA (create your own playlist by defining the order of the tracks in the DVD Player's *Program Play* menu—page 25.)

Introscan: Audio CDs only. Plays the first 10 seconds of each track.

Repeat

By default, the Repeat feature is Off. The options available depend upon the type of disc you're playing.

- With a DVD disc, you can repeat the title, chapter, or use A-B Repeat.
- With Audio CDs, you can repeat the disc, a track, or a program (you must create the program via the *Program Play* option in the *Play Mode* menu—directions are on page 25).
- With CD-Rs and CD-RWs that have mp3 and/or WMA files on them, you can repeat the disc, a track, a program, or a folder.

Repeating Discs, Titles, Chapters, or Tracks

1. While a disc is playing, press INFO (the Info Display appears).
2. Press the ► button until the Play Mode icon is highlighted.
3. Press the ▲ or ▼ button to scroll through the different options until you see the repeat option you want to use (the options appear in the text box at the bottom of the Info Display) and press OK to activate.
4. To turn off the Repeat feature, press the ▲ or ▼ button repeatedly until *Play Mode: Standard* appears, and press OK to activate.

Note: To repeat a Program (Audio CD, mp3 files, and WMA files), you must set up the program via the DVD Player's Program Play option in the Play Mode menu before the selection will be available in the Info Display. For instructions, go to page 25.

Playing Discs

AB Repeat (DVDs only)

AB Repeat lets you define a specific segment on the disc that you want to repeat. To watch a scene over and over:

1. With the Play Mode icon highlighted in the Info Display, press the ▲ or ▼ buttons until *Repeat Mode: AB*. Press OK to set A point appears at the bottom of the Info Display. Press OK when the disc gets to the beginning point of the segment (the A point) that you want to repeat.
2. Allow the disc to play to the end of the segment you want to repeat. Don't fast forward - the disc has to play in standard playback mode to set the B point (the end point of the segment). Press OK to set the B point (the segment will play repeatedly until you turn off the Repeat feature).
3. To turn off the Repeat feature, press the ▲ button on the remote until *Play Mode: Standard* appears at the bottom of the Info Display, and press OK. Repeat is also cancelled when you remove the disc.

Random (Audio CD, mp3, WMA)

1. With the Play Mode icon highlighted in the Info Display, press the ▼ button until *Play Mode: Random* appears in the text at the bottom of the Info Display, and press OK (the tracks start playing in random order).

To switch back to Standard Playback, press the ▲ or ▼ button repeatedly until *Play Mode: Standard* appears in the text bar underneath the Info Display icons, and press OK.

Note: The player defaults to Standard Playback whenever you put a new CD into the DVD player.

Program Play (DVD, Audio CD, mp3, WMA)

The Program Play Mode is only available after you set up a program through the DVD Player's menu. Go to page 25 for instructions.

Introscan (Audio CDs only)

Use this feature to preview the first few seconds of each track on a CD.

After you've highlighted the Play Mode icon, press the ▲ or ▼ button on the remote until *Play Mode: Introscan* appears. If necessary, press the OK button (the first few seconds of each track start playing).

- After Introscan previews all of the tracks, the disc starts playing from the beginning.
- To stop Introscan, press the STOP button (the main menu appears).



Bookmark Icon (DVD Info Display)

The Bookmark feature lets you mark a point on the disc so you can quickly start playing the disc from a bookmarked point.

Creating a Bookmark

1. Highlight the Bookmark icon on the Info Display. Press OK (the Bookmark Banner appears).
2. Highlight an unused bookmark. When the disc reaches the scene you want to mark, press the OK button on the remote (the bookmark icon changes to two icons side-by-side: an arrow and a trash can).

To play the disc from the bookmarked scene, highlight the play arrow icon and press the OK button.

To delete the bookmark, highlight the trash can and press OK.

3. To remove the Info Display and/or Bookmark Banner, press the INFO button on the remote.

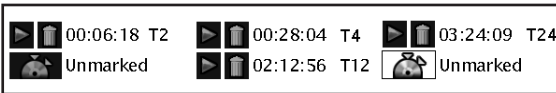

This is the Bookmark Banner.

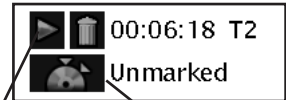

Play arrow icon Unused bookmark icon

Using a Bookmark

1. While you're playing a disc, press the INFO button on the remote (the Info Display appears).
2. Press the ► button to highlight the Bookmark icon, and press OK (the Bookmark Banner appears).
3. Use the ◀, ▶, ▲ and ▼ buttons on the remote to highlight the play arrow icon that's next to the bookmarked scene you want to activate.
4. Press OK (the disc starts playing from the bookmarked scene).

Clearing a Bookmark

The bookmarks are erased each time you remove a disc from the player or when the power is turned off.

1. While you're playing a disc, press the INFO button on the remote (the Info Display appears).
2. Press the ► button to highlight the Bookmark icon, and press OK (the Bookmark Banner appears).



Trash can icon

3. Use the ◀, ▶, ▲ and ▼ buttons on the remote to highlight the trash can icon that's next to the bookmarked scene you want to delete, and press OK (the bookmark is cleared, and the trashcan icon changes back to an unused bookmark icon).

Playing Discs



Camera Angle Icon (DVD Info Display)

Some discs contain multiple angles of a particular scene or sequence. If the disc only has one angle, this feature won't work. Currently, very few discs have this feature.

1. While a disc is playing, press ANGLE on the remote. If the disc wasn't created with multiple angles, the invalid symbol appears. If the disc contains multiple angles, the Angle icon appears with the current angle number and the number of angles available. For example, 1/4 indicates that Angle 1 is displayed and there are 4 different angles available.
2. Press the ▲ and/or ▼ button to see the next angle.



Playback Control Icon (VCD Info Display)

This function enables you to make interactive selections of some scenes. Additionally, high resolution scenes can be viewed if they are included on the disc. Highlight the PBC icon, and use the ▲ and/or ▼ buttons to scroll through options available on the disc.

Playing mp3, WMA, or JPEG files

mp3 is an audio file format which compresses recorded music. It was developed by Fraunhofer Gesellschaft in collaboration with Thomson Inc. The main advantage of the mp3 format is the ability to store CD-quality music tracks that are user-friendly and compressed on a personal computer.

WMA (Windows Media Audio) is another audio file format, developed by Microsoft.

JPEG files are image files. Make sure that they have a resolution of less than 5 megapixels (2 MB).

Note: The time taken for the contents of the disc to be displayed varies according to the size and number of JPEG files actually on the disc. If nothing is displayed after a few minutes, it is likely that certain files are too large. In this case, reduce the files' resolution to less than 5 megapixels and write another disc.

Your player can play the following combinations:

mp3 files only

jpeg files only

WMA files only

JPEG and mp3 files at the same time (Musical Slide Show)

This on-screen arrow indicates that there are more files/folders listed above the current list—press ▲ (the up arrow button) on the remote control to scroll through the list.

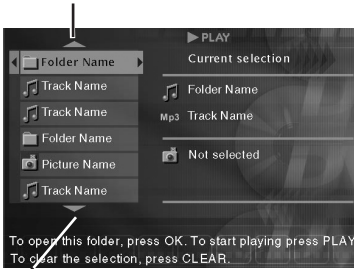

Press ▼ (the down arrow button) on the remote control to see the other files/folders that are on the disc.



Music icon: denotes an mp3 or WMA music file



Camera icon: denotes a JPEG picture file



Folder icon: to play all the files in the folder, highlight the folder and press PLAY. To see the files inside the folder, press OK.

Basic Navigation

To navigate through the discs contents, use the ◀, ▶, ▲ and ▼ buttons on the remote control to highlight various files or folders.

The arrows (triangles) on the screen indicate which way you can go to see more files/folders (see picture on the left for example).

Basic Playback

1. Place the disc in the tray with the printed side facing up, and close the disc tray.
2. If you selected *AutoPlay On* in the *Play Mode* menu (see page 25), the files/folders on the disc appear automatically. If the file/folders don't appear, press PLAY (the disc's contents appear).

When a folder is highlighted:

- Press OK to see the files in the folder.
- Press PLAY to play the files in the folder.

When a file is highlighted, press PLAY to play the file.

Playback Details

Once you've inserted the disc and selected your file/folder from the on-screen list and you start playing music:

- **mp3 or WMA file:** the player begins by playing the selected file, then all the files and subfolders contained in the same folder. The player then plays the contents of the folders at the same level as the folder containing the file selected at the start.

While listening you can use the ◀ or ▶ button to go back to the previous track or go to the next one.

To see the disc's contents, press the MENU button.

To access the Info Display, press the INFO button.



To access the Info Display, press INFO during playback. To access repeat playback features, use the ▲ and ▼ buttons on the remote to scroll through the choices.

Playing Discs

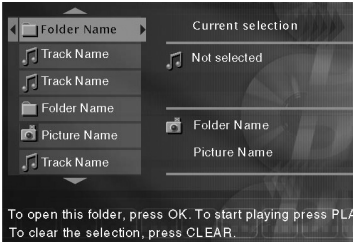

Playback Details (continued)

Once you've inserted the disc and selected your JPEG file/folder from the on-screen list:

- **JPEG file:** the player starts the slide show with the JPEG file you have selected and proceeds to display all the JPEG files in the same folder, then all the JPEG files in the subfolders located in the same folder.

During the slide show press the ANGLE button to rotate the picture 90°.

To magnify the picture, press the ZOOM button.

To go back to the previous picture, press the ◀ button; and to go to the next picture, press the ▶ button.

To interrupt the slide show and display the disc's contents, press the MENU button.

To access the Info Display, press the INFO button.



JPEG Info Display: during playback, press INFO on the remote control. To change the slide show speed, press the ▲ button to access different options.

Musical Slide Show: playing JPEG and mp3 files at the same time

You can display JPEG files while listening to mp3 music files recorded on the same disc.

1. Insert the disc containing the music and picture files in the player. If a choice list appears, highlight the choice that matches the types of files on the disc and press OK.
2. Then select an mp3 music file using the ◀, ▶, ▲ and ▼ buttons, then press OK to confirm your selection. The name of the folder where the file is located and the name of the file appear on the right in the *Current selection* section.

Note: To delete your selection, press the CLEAR button.

3. Select a picture file (JPEG) using the ◀, ▶, ▲ and ▼ buttons, then press OK to confirm your selection. The name of the folder where the file is located and the name of the file appear on the right in the *Current selection* section.

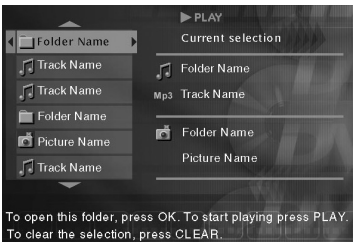

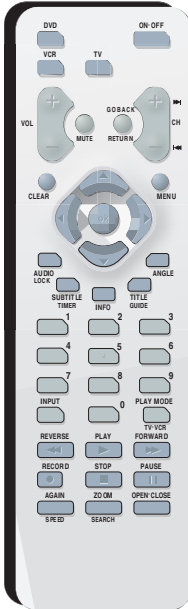

4. Press the PLAY button to start playing the two files at the same time.

Note: You can also select a folder containing JPEG and mp3 files using the ◀, ▶, ▲ and ▼ buttons, then press PLAY. In this case, the player starts playing the pictures and music at the same time beginning with the first file of each type.

- The player starts the slide show with the JPEG file selected and proceeds by displaying all the JPEG files in the same folder, and then all the JPEG files in the subfolders located in the same folder.

At the same time, the player plays the selected mp3 file, then all the mp3 files in the same folder, and finally the mp3 files contained in the folders located at the same level as the folder containing the file selected at the start.

Note: If the mp3 files are finished playing before the end of the slide show, the player starts playing the mp3 files again until the slide show ends.

5. During simultaneous playback you can use the ANGLE button to rotate the picture 90°, the ZOOM button to magnify the picture, the ◀ or ▶ buttons to go back to the previous picture or go to the next one.
6. When the player has played all the files, the disc's contents appear.
7. Press STOP to end playback.

The DVD Player Menu System

The DVD player menu system is not the same as the disc menu or the Info Display. The DVD player menu appears when there's no disc playing. If you are playing a disc, press STOP on the remote control to stop playback (the DVD player menu appears). If the screensaver is on the screen, press STOP or CLEAR.

Use the arrow buttons, ◀, ▶, ▲ and ▼, on the remote to highlight different menu items. Use the OK button to select a menu that is highlighted.

Throughout the menu system, text appears at the bottom of the page to explain what to do.

To return to a previous menu, press the ◀ (left arrow) button.

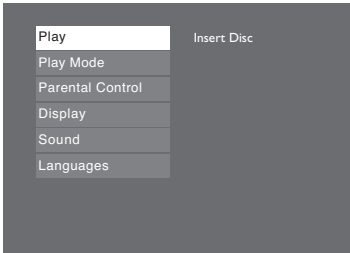

The Play Menu

The *Play* menu doesn't have submenus or options like the other main menu options. Instead the status changes: if you're playing a disc and access the main menu, the menu appears as *Resume Play*; if you haven't started playing the disc, the title of the disc appears next to the *Play* menu.

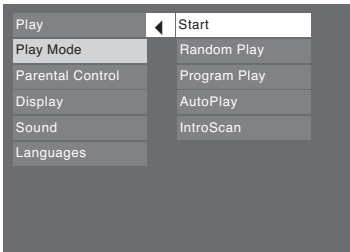

The Play Mode Menu

Discs are formatted to play chapters (or tracks on audio CDs) in a certain (standard) order. If you'd like to play chapters or tracks in a different order, you can use the *Play Mode* menu to do so. You must have a disc in the player with the disc tray closed in order to access all of the *Play Mode* items.

Note: All of the play mode options, except for AutoPlay can be accessed during playback via the DVD player's Info Display (page 17).

Standard Play (Start)

The DVD Player's default play mode is standard, meaning the chapters and tracks on a disc play in the order listed on the disc — starting with chapter (track) 1.

Random Play (Audio CD, mp3, WMA)

The *Random Play* option plays a disc's tracks in random order. Use the arrow buttons to highlight *Random Play*, and press the OK button.

To stop Random playback, press the STOP button twice. To resume normal playback, press PLAY.

Program Play (Audio CDs)

With this option, you choose the order in which the tracks play.

1. Highlight *Program Play*, and press the OK button (the Program Playlist screen appears). Follow the on-screen instructions to create your program:
 - 1a. Audio CD: select a track using the ▲ and ▼ buttons, or select *All* to start playing all the tracks.
 - 1b. mp3 or WMA CD: select a folder using the ▲ and ▼ buttons, then press the ► button to access the list of files, then select a file using the ▲ and ▼ buttons.
2. Press OK to add the track (audio CD) or file (mp3 or WMA) selected, to the list. Press the CLEAR button to remove the last track/file from the list. Press PLAY to start program play. Repeat steps 1 and 2 as often as necessary.
3. You can play your program by highlighting *Play* and pressing the OK button, or you can save the program to play later by highlighting *Done* and pressing OK.

AutoPlay

You can set up the DVD Player so a disc automatically starts playing whenever the disc tray is closed.

Highlight *AutoPlay* and press OK (*On* appears next to the *AutoPlay* menu). To turn *AutoPlay* off, just press OK again while *AutoPlay* is highlighted.

Note: AutoPlay isn't available for mp3 or WMA discs (if you have selected AutoPlay On, the disc's contents will appear automatically when you insert the disc).

Introscan (Audio CDs, mp3, WMA)

This option enables you to preview the first few seconds of each track on a CD.

After you've highlighted the *Introscan* menu, press OK (the first few seconds of each track start playing); press STOP to stop Introscan or PLAY to continue playing the current track.

Note: Introscan is also available while you're playing a CD via the Info Display (page 18).

Menu System

The Parental Control Menu

You can set up ratings limits and lock your player in order to control the type of content people watch on your DVD Player. The padlock icon indicates whether the player is locked or unlocked.



Locked: You need to enter the password in order to play discs that have a higher rating than what you've allowed. When the player is locked, nobody can access the *Parental Control* menu without entering the password.



Unlocked: No password required to play discs. Even if you've set ratings limits, they won't be enforced when the player is unlocked.

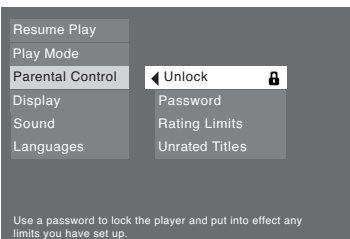
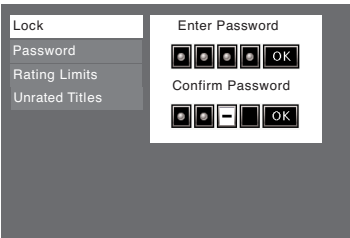
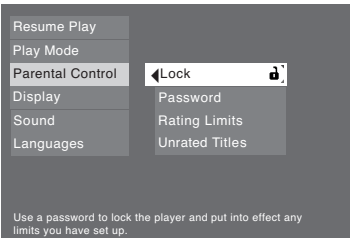

Locking your DVD Player

1. If you're playing a disc, press STOP (the DVD Player's main menu appears).
2. Press the ▼ button until *Parental Control* is highlighted, and press OK (the *Parental Control* menu items appear).
3. Since *Lock* is highlighted, just press the OK button on the remote (the *Enter Password* screen appears).
4. Use the number buttons on the remote control to enter your password and press OK (*Confirm Password* appears). Enter the same numbers you entered before and press OK (if necessary, press the ◀ button to return to the previous menu).

Notes:

Once the player is locked, you'll need to enter the password everytime you access the *Parental Control* menu.

The player is shipped without any rating limits set. You need to set *Ratings Limits* (go to page 27 for instructions) in order for the player to prevent people from playing discs with certain ratings.

Unlocking your DVD Player

1. If you're playing a disc, press STOP (the DVD Player's main menu appears).
2. Press the ▼ button until *Parental Control* is highlighted, and press OK (the *Enter Password* screen appears).
3. Use the number buttons to enter the password you created, and press OK (the *Parental Control* menu items appear).
4. If necessary, press the ▼ button until *Unlock* is highlighted and press OK. If asked, enter your password to confirm that you want to unlock the player (if necessary, press the ◀ button to return to the previous menu).

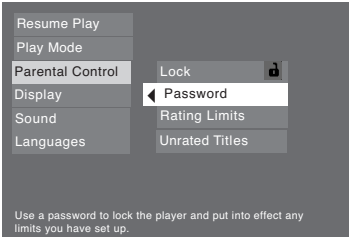

Changing Your Password

You can change your password, but the player must be locked.

1. If a disc is playing, press STOP (the main menu appears).
2. Press the down arrow button until *Parental Control* is highlighted, and press OK. If asked, enter your current password (the *Parental Control* menu items appear).
3. Press the ∇ button to highlight *Password*, and press OK (the *Enter New Password* screen appears).
4. Use the number buttons on the remote to enter the four-digit number that you want to use as your new password, and press OK (you will be prompted to enter your new password again to confirm). Enter your password, and press OK.

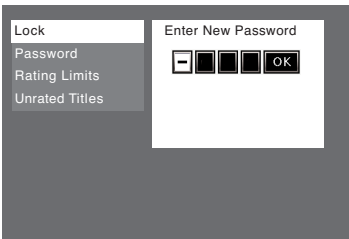

Explanation of Ratings Limits

The Rating Limits feature lets you determine what types of discs can be played in the player, and what types of discs will require a password to override the rating limit that you've set. In the United States of America (USA), the ratings feature is based on the ratings set up by the MPAA (Motion Pictures Association of America) such as R, PG, G, etc. Some countries use a different rating system.

The system ranks the ratings from 1 to 8 in order to accommodate the rating systems used in other countries (Movies that are rated as Level 1 contain the least offensive material and are considered to be appropriate for young audiences. Level 8 movies are considered the most offensive).

Note: In order for the Ratings Limits to be enforced, the DVD Player must be locked and the disc you're playing must contain a movie (or a title) that is rated.

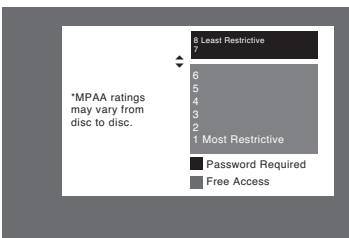

To set Ratings for Rated Titles:

The *Rating Limits* menu enables you to block discs that contain movies that have a rating assigned to them (R, PG-13, PG, G, etc.) from being played unless you enter the password you created in the *Password* menu.

1. From the main menu, highlight *Parental Control* and press OK (enter your password if asked).
2. Highlight *Rating Limits* and press OK (the 8-level rating list appears).
3. Use the \blacktriangle or \blacktriangledown buttons to move the bar to the highest rating you find acceptable.

Menu System

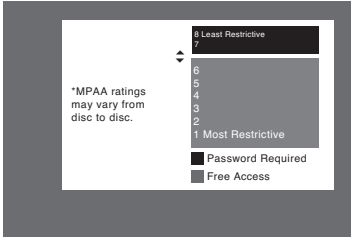

Note: Ratings that won't require a password (free access) appear under the bar. Ratings that will require a password, appear above the bar.

4. Press OK.
5. To return to the main menu, press the ◀ button until the main menu appears on the screen.

Unrated Titles

Some discs contain titles that don't have a rating assigned to them. Sometimes, movies you might find the most explicit are unrated. However, many of the bonus features on DVDs, such interviews with actors, directors, etc., are also unrated.

You can restrict access by requiring a password for unrated titles.

1. From the main menu, use the ◀, ▶, ▲ and ▼ buttons to highlight *Parental Control* and press OK (enter your password if asked).
2. Press the ▼ button until *Unrated Titles* is highlighted, and press OK (another screen appears).
3. Press the ▼ button to highlight *Password Required*, and press OK (your password will be required to play *Unrated Titles* as long as you make sure you lock the player).
4. To return to the main menu, press the ◀ button until the main menu appears on the screen.

Note: You must lock the player in order for ratings limits to be enforced.



The Display Menu

The *Display* menu contains the settings that affect how a disc's content looks on your TV.

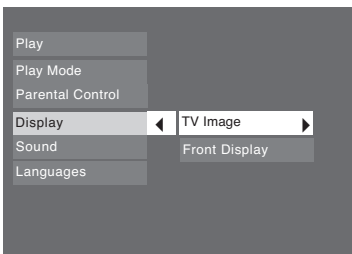

TV Image

The *TV Image* menu adjusts the way a movie appears on your TV. Standard TVs are 4 x 3 format. Depending on the type of television you have, you may want to adjust the screen setting (also called the aspect ratio).

1. With the player on (no disc playing), press MENU (the main menu appears). If a disc is playing, press STOP.
2. Use the ▲ or ▼ buttons to highlight *Display*. Press the OK button on the remote (the *Display* choices appear).

3. Since the *TV Image* is the first submenu, it's already highlighted. Press the OK button (the *TV Image* options appear).
4. Use the ▲ or ▼ buttons to highlight your choice (the options are explained below), and press OK to select.



4 x 3 Letterbox – Choose this setting if you want to see movies in their original aspect ratio (height-to-width ratio). You'll see the entire frame of the movie, but it will take up a smaller portion of the screen vertically. The movie might appear with black bars at the top and bottom of the screen.



4 x 3 Standard – Choose this setting if you want the movie to fill the entire screen of your TV. This might mean that parts of the picture (the left and right edges) won't be seen.



16 x 9 Widescreen – Choose this setting if your DVD Player is connected to a wide-screen TV. If you choose this setting and you don't have a widescreen TV, the images on the screen might appear distorted due to vertical compression. If you play a disc recorded in 4 x 3 format on a widescreen TV, the left and right side of the screen will appear black.

Menu System

Front Display

You can change the brightness of the display on the front of your DVD player to suit the lighting of the room.

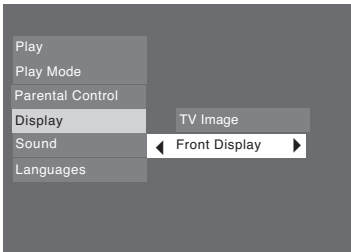
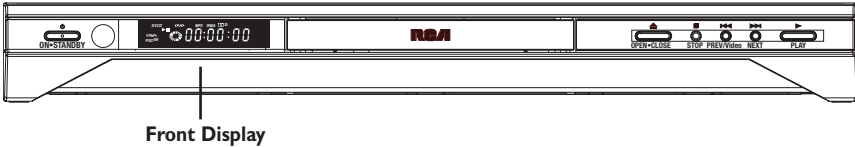

1. From the *Display* menu highlight *Front Display* and press OK (the choices appear):
Dim for Movies (display dims when a disc is playing)
Off for Movies (no display when a disc is playing)
Always Bright
Always Dim
2. Highlight the setting you want to use, and press the OK button.
3. To return to the previous menu, press the ◀ button if necessary.

The Sound Menu

The *Sound* menu lets you adjust the player's settings to match the equipment you connected to your DVD Player, and to use the DVD Player's Sound features.

Sound Logic

The Sound Logic feature compresses the dynamic range (quietest sound to loudest sound) of a disc's soundtrack to even out the volume range.

1. From the Main Menu, (player on, no disc playing), highlight *Sound* and press the OK button on the remote (the *Sound* options appear).
2. Since *Sound Logic* is already highlighted, press the OK button (the *Sound Logic* options appear).
3. Use the ▲ or ▼ buttons to highlight your choice and press OK.
4. To return to the previous menu, press the ◀ button if necessary.

Note: The performance of the Sound Logic feature varies depending upon the equipment you have connected to your DVD Player and the audio format of the disc you're playing.

Virtual Surround

The Virtual Surround[®] feature simulates a six-speaker listening experience through just two speakers.

1. From the Main Menu, (player on, no disc playing), highlight **Sound** and press the OK button on the remote (the **Sound** options appear).
2. Press the ▼ button on the remote control to highlight **Virtual Surround** and press OK (the options appear)
3. Highlight your choice, and press OK. To return to the previous menu, press the ◀ button.

Note: The performance of the Virtual Surround feature varies depending upon the equipment you have connected to your DVD Player and the audio format of the disc you're playing.

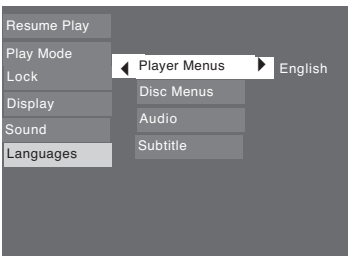

The Languages Menu

The **Languages** menu enables you to set preferred language options for:

- **Player Menu** (the DVD Player's menu system)
- **Disc Menu**
- **Audio** (the dialogue of DVD titles)
- **Subtitles**

The way you choose languages is the same for each of the **Languages** submenus.

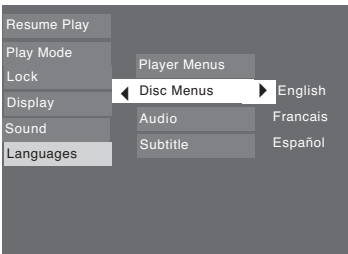

1. From the Main Menu, (player on, no disc playing), highlight **Languages** and press the OK button on the remote (the **Languages** options appear).
2. Use the ▲ or ▼ buttons to highlight the option you want to change, and press OK (the languages appear).
3. Press the ▲ or ▼ buttons to highlight the language you want to use and press OK.
4. To return to the previous menu, press the ◀ button if necessary.

Notes:

Discs are created differently. The DVD player can't override some language preferences. If a disc's software was created to play the movie (title) in a preferred language, the preference you set might be ignored.

Also, if the language isn't available on the movie you're playing, the disc's default language will be chosen.

You must turn on the Subtitle feature in order for them to appear when you're playing a disc.

If the disc wasn't created with subtitles, you won't be able to use the Subtitle feature.

If the disc wasn't created with the Subtitle language you choose in the Subtitles menu, the disc's default subtitle language will be chosen.

Troubleshooting

You can correct most problems you have with your product by consulting the Troubleshooting list that follows.

Note for U.S. customers: If you prefer, we can provide you with the name of an Authorized Service Representative who will visit your home for a fee to install your electronic entertainment system and to instruct you in its operation. For details about this service, call 1-888-206-3359.

For additional assistance while using your RCA products, please visit www.rca.com/customersupport.

Player won't work

- Reset the player: press and hold the NEXT ► button on the front of the DVD Player and press the STOP button on the remote at the same time — wait at least 5 seconds before you release both buttons. Turn the DVD Player off and then turn it back on. You'll need to set up your menu preferences if you changed them since this Reset Procedure returns the DVD Player's menus to the settings they had when the product shipped to retail stores.
- Try unplugging the AC power cord, wait 2 minutes, and plug it back in.

No power

- Plug in the DVD Player. Make sure both ends of the AC power cord are securely plugged into the player and into an AC outlet.

Player turns off automatically

- The power automatically turns off after the player has been in stop mode for approximately 30 minutes. Turn power back on.

Disc won't play

- Insert a disc with the label side facing up.
- Check the type of disc you put into the player. This player only plays DVD video discs, DVD audio discs, Video CDs, CDs with mp3 files, WMA files and/or JPEG files on them, and audio CDs.
- If you're trying to play a disc with JPEG files on it, you need to make sure only files with a resolution of 5 megapixels (about 2MB) are burned onto the disc. The player might not read the disc if the disc has larger files on it.
- Both the player and the disc are coded by region. If the regional codes don't match, the disc cannot be played. This player is Region No. 1.

Forget Password

- Try entering 9999. If that doesn't override Parental Control, press and hold the STOP button on front of player and the STOP button on the remote. Release both buttons after 2 seconds.

Play starts, but then stops immediately

- The disc is dirty. Clean it.
- Condensation has formed. Allow player to dry out.

No picture

- Turn on the TV.
- Tune your TV to its Video Input Channel (go to page 9).
- Make sure your player is connected properly.
- You might have set your DVD player to Progressive Scan when the TV you've connected it to isn't a progressive scan TV (page 35). Since the VIDEO jack always sends an interlaced signal, reset the DVD player; press and hold the STOP button on the remote control and the SKIP FWD ► button on the front of the player at the same time — wait at least 5 seconds before you release both buttons.

No sound or distorted sound

- Make sure your player is connected properly. Make sure all cables are securely inserted into the appropriate jacks.
- Make sure you've connected the audio cables (red and white).
- Turn your TV to its Video Input Channel (go to page 9).
- Sound is muted when you're using search features (fast forward, reverse, etc.).
- If you connected an audio receiver to your DVD Player, make sure you chose the correct input setting on the receiver.

Remote control won't work

- You might be in the wrong mode. To operate your DVD Player, press the DVD button on the remote before you press any other buttons. If you're operating the TV, press the TV button first, etc. (this remote operates most RCA, GE, and Proscan TVs).
- Check battery installation— the direction of the + and – on the batteries must match information in battery compartment cover.
- Insert new batteries in the remote.
- Operate the remote control at a distance of no more than 20 feet.
- Remove any obstacles between the remote and the DVD Player. If your DVD Player is in an entertainment cabinet, the glass doors might obstruct the remote control from operating the DVD Player. Open the doors.
- Drain the remote's microprocessor — remove the batteries; press and hold the I button for 60 seconds; replace the batteries and try the remote again.

Can't advance through a movie

- You can't advance through the opening credits and warning information that appear at the beginning of movies because the disc is programmed to prohibit that action.

The invalid icon appears on screen

The feature or action cannot be completed at this time for one of the following reasons: the disc's software restricts it; the disc's software doesn't support that feature (e.g., angles); the feature is not available at the moment; you've requested a title or chapter number that is out of range.

The picture is distorted

- Did you connect your VCR to the DVD Player? Disconnect it, and connect the VCR directly to the TV and the DVD Player directly to the TV. See chapter 1 for correct setup and connection information.
- The disc might be damaged. Try another disc.
- If you're using FORWARD or REVERSE buttons, it is normal for some distortion to appear while scanning.

A screen saver appears on the TV

- Your player is equipped with a screen saver that appears on the TV after your player has been idle for several minutes. To make it disappear, press STOP or CLEAR on the remote.

Subtitle and/or audio language is not the one selected from the initial setting

- If the subtitle and/or audio language does not exist on the disc, the initial settings will not be seen/heard. The disc's priority language is selected instead. Set the subtitle and/or audio language manually through the Info Display or the player menu.

Disc tray won't open

- Press and hold STOP key on front of player, and then press and hold the ON/OFF button on the remote control. Keep pressing both buttons simultaneously for 2 seconds.

Additional Information

Maintenance of Cabinet

For safety reasons, when cleaning the cabinet be sure to disconnect the AC power cord from the AC outlet.

- Do not use benzene, thinner, or other solvents for cleaning.
- Wipe the cabinet with a soft cloth.

Formation of Condensation

- Due to sharp changes in temperature and humidity, condensation may form if warm air comes in contact with any cold parts inside the player.
- When condensation forms inside the player, the player may not operate correctly. If this occurs, leave the player at room temperature until the inside of the player becomes dry and operational.
- If condensation forms on a disc, wipe the disc with a soft, dry cloth by moving the cloth from the center hole toward the outer edge.

Handling Discs

- Don't touch the disc's signal surfaces. Hold by the edges or by one edge and the hole in the center.
- Don't affix labels or adhesive tape to label surfaces. Don't scratch or damage the label.
- Do not use damaged (cracked or warped) discs.

Cleaning Discs

- Dirty discs can cause reduced video and audio performance. Always keep discs clean by wiping them gently with a soft cloth from the inner edge toward the outer perimeter.
- If a disc becomes dirty, wet a soft cloth in water, wring it out well. Wipe the dirt away gently, and remove any water drops with a dry cloth.
- Do not use record-cleaning sprays or anti-static agents on discs. Also, never clean the discs with benzene, thinner, or other volatile solvents which may cause damage to the disc surface.

Handling Cautions

- Before connecting other components to this player, be sure to turn all components off.
- Don't move the player while a disc is being played. The disc may get scratched or broken, and the player's internal parts may be damaged.
- Don't put any container filled with liquid or any small metal objects on the player.
- Be careful not to put your hand into the disc tray.
- Don't place anything other than the disc in the disc tray.
- Exterior influences such as lightning and static electricity can affect normal operation of this player. If this occurs, turn the player off and on again with the ON•OFF button, or disconnect and then reconnect the AC power cord to the AC power outlet. The player will operate normally.
- Be sure to remove the disc and turn off the player after use.

Progressive Scan

If your TV is capable of displaying Progressive Scan video, you must do three things to watch DVDs in Progressive Scan format—make sure your TV is a Progressive Scan TV; connect the DVD player to the TV via the COMPONENT OUT jacks (Y, Pb, Pr); and turn on Progressive Scan in the DVD player.

- 1) Make sure your TV is a Progressive Scan TV (check the owner's manual)
- 2) Connect the DVD Player to the Progressive Scan TV via the COMPONENT VIDEO jacks

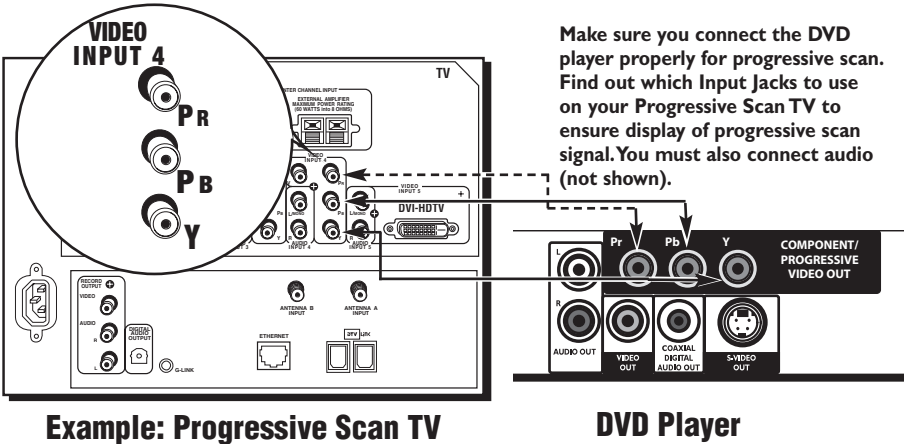

- 3) Change DVD Player Video Output to Progressive Scan



With your DVD Player turned on, and your TV turned on press and hold the **PREV/VIDEO** button for at least 3 seconds (this puts you into Video Output mode). Press the **PREV/VIDEO** button to access different video output options. Each time you press **PREV/VIDEO**, the type of video being displayed appears next to the *Display* menu.

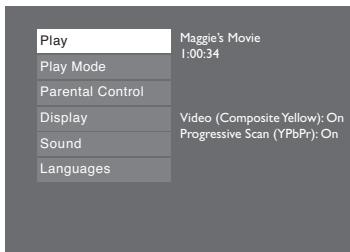

Additional Information

Progressive Scan Troubleshooting

Some high-end HDTVs and multimedia monitors offer progressive scanning of the video signal instead of interlace. Proponents of Progressive Scan say it provides a crisper picture because it eliminates the “flicker” or “jitter” at the edges of the screen. Your DVD player is equipped to send a progressive scan signal (page 35).

IMPORTANT:

If you don't have a Progressive Scan TV or you don't have the DVD player connected to the correct Input Jacks, and you activate Progressive Scan in the DVD player you won't see a picture! Don't panic—try the following:

First, press the PREV/VIDEO button on the front of the DVD player (it will go to the next video output option, which is an interlace output so a picture should appear on the TV screen).

If that doesn't work, press and hold PREV/VIDEO button on the front of the DVD player for 3 seconds. Now, press the PREV/VIDEO button again (it will go to the next video output option, which is an interlace output so a picture should appear on the TV screen).

If you still don't see a picture on your TV screen, make sure the yellow cable (provided) that is attached to white and red cable (called audio/video cables) is connected to the DVD player's PREV/VIDEO jack and the TV's Video Input jack. Change your TV channel to your TV's Video Input channel that activates the TV's Video Input jack where you have connected the yellow cable (page 9 has more information). This PREV/VIDEO jack on the DVD player always outputs interlace video, so you should see a picture on the TV screen.

As a last resort, you can reset the DVD player to the factory default settings:

Press and hold the STOP button on the remote control and the NEXT ► button on the front of the player at the same time — wait at least 5 seconds before you release both buttons.

Recommendations and information concerning discs

CD-R and CD-RW discs

This player can play most CD-R and CD-RW discs. However, depending on the recorder of the discs of your personal computer, the type of disc and recording method used, some discs might not play, or the performance might not meet the expected standard of quality. When playing a CD-R disc, it is completely normal for the unit to take up to 20 seconds to recognize the disc before it plays. If the disc is not recognized after a period of 20 seconds, remove the disc, and then insert it again. If after several trials, the disc cannot be recognized, make sure you have followed the recommendations below or try another type of disc.

- Whatever the actual recording capacity of a disc, do not fill it to maximum capacity.
- Use CD-R discs rather than CD-RW (re-recordable CDs), as replay of CD-RWs may sometimes not work properly.
- Use a reliable and good quality recording software.
- Before recording on a disc, close all applications on your personal computer in order to optimize the quality and reliability of recordings on the disc.

CD-R and CD-RW discs with mp3 format “Sound” files

In the case of discs that include mp3 files, follow not only the general recommendations for CD-R and CD-RW discs, but also the following specific recommendations:

- The format of your mp3 files should be ISO 9660 or JOLIET. These files are compatible with DOS and Windows applications as well as with Mac OS.
- Your mp3 files must have a name no longer than 12 characters as well as the suffix “.mp3”. They must be recorded in the form: title.mp3. Ensure that you do not leave spaces or use special characters such as (. , / , \ , = , +) in the name.
- Do not attempt to record protected mp3 files. Such files are coded and protected.
- Use a decompression transfer rate of at least 128 kb/sec (kilobytes/second) when recording mp3 files. Sound quality with mp3 files basically depends on the rate of compression/decompression you choose. Getting audio CD quality sound requires an analog/digital sampling rate, that is conversion to mp3 format, of at least 128 kb/sec and up to 160 kb/sec. However, choosing higher rates, like 192 kb/sec or more, only rarely give even better sound quality. Conversely, files with sampling rates below 128 kb/sec will not be played properly.

Important: The above recommendations cannot be taken as a guarantee that the DVD player will play mp3 recordings, or as an assurance of sound quality. You should note that certain technologies and methods for mp3 file recording on CD-Rs prevent optimal playback of these files on your DVD player (that is degraded sound quality and even, in some cases, inability of the player to read the file or files).

Additional Information

CD-R and CD-RW discs with JPEG format “image” files

To view your JPEG images on a TV set you do not need to record your photographs with a resolution above 400,000 pixels (which corresponds to an image format of about 720 x 576 dots) because of the resolution of most TVs. Due to this, reduce the quality of your photographs before recording on a disc in order not to impede the proper running of your player. This is because excessively loaded pictures would slow down or might prevent the proper functioning of the slide show during playback on your player. Compatibility of JPEG files depends on the software on which they were created and on the size of files expressed in pixels. Some JPEG files, including Continuous JPEG files (displayed in stages) cannot be played on this player.

Video CD (VCD) discs

VCD (Video Compact Disc) discs enable up to 74 minutes of VHS quality video associated with still pictures, audio tracks and interactive menus to be recorded on a CD.

Super Video CD (SVCD) discs

SVCD (Super Video Compact Disc) discs comply with standard IEC62107, making it possible to record up to 70 minutes of digital images and sound at standard MPEG-2 for video and MPEG-1 for audio. Compatibility of SVCD discs depends on the MPEG coding software, the disc design software, as well as the recording software used and the discs themselves.

DVD-R and DVD-RW discs

Your player can play DVD-R and DVD+R (single recording) and DVD-RW and DVD+RW (re-recordable) discs. Recordings on DVD-RW discs must be made in DVD Video mode. Recordings on DVD+RW discs must be made in accordance with the specifications for the 4.7 Gb capacity DVD+RW disc format. Compatibility is dependent on which DVD writer, writer software and discs are used.

Important: Despite considerable progress made in providing compatibility with as many different discs as possible, reading of discs not conforming to Audio CD, Video CD and Super Video CD (S-VCD) disc standards cannot be guaranteed.

Limited Warranty

What your warranty covers:

- Defects in materials or workmanship.

For how long after your purchase:

- 90 days from date of purchase - Unit exchange, which includes parts and labor.
- 91 days to 1 year from date of purchase - Unit exchange, which includes parts only; you pay the labor.
- The warranty for rental units begins with the first rental or 45 days from date of shipment to the rental firm, whichever comes first.

What we will do:

During the initial 90 days:

- Provide you with a new, or at our option, a refurbished unit. The exchange unit is under warranty for the remainder of the original product's warranty period.

After the 90 days and within one year:

Provide you with a new, or at our option, a refurbished unit. The exchange unit is under warranty for the remainder of the original product's warranty period. We will bill you a flat exchange charge to replace a defective unit. This charge covers the labor cost for its repair.

How to make a warranty claim:

- Properly pack your unit. Include any cables, etc., which were originally provided with the product. We recommend using the original carton and packing materials.
- Proof of purchase in the form of a bill of sale or receipted invoice which is evidence that the product is within the warranty period must be presented to obtain warranty service. For rental firms, proof of first rental is also required.
- Also print your name and address and a description of the defect. Send via standard UPS or its equivalent to:

Thomson Inc.
11721 B Alameda Avenue
Socorro, Texas 79927

- Pay any charges billed to you by the Exchange Center for service not covered by the warranty.
- Insure your shipment for loss or damage. Thomson accepts no liability in case of damage or loss en route to Thomson.
- A new or refurbished unit will be shipped to you freight prepaid.

Additional Information

What your warranty does not cover:

- Acts of nature, such as but not limited to lightning damage.
- Adjustment of customer controls.
- Damage from misuse or neglect.
- A unit that has been modified or incorporated into other products or is used for institutional or other commercial purposes.
- Batteries.
- Units purchased or serviced outside the U.S.A.
- Shipping damage if the unit was not packed and shipped in the manner prescribed by Thomson.

Product Registration:

Please complete the online Product Registration on www.rca.com/productregistration or complete and mail the Product Registration Card packed with your unit. It will make it easier to contact you should it ever be necessary. The return of the card is not required for warranty coverage.

Limitation of Warranty:

- THE WARRANTY STATED ABOVE IS THE ONLY WARRANTY APPLICABLE TO THIS PRODUCT. ALL OTHER WARRANTIES, EXPRESS OR IMPLIED (INCLUDING ALL IMPLIED WARRANTIES OF MERCHANTABILITY OR FITNESS FOR A PARTICULAR PURPOSE) ARE HEREBY DISCLAIMED. NO VERBAL OR WRITTEN INFORMATION GIVEN BY THOMSON INC., ITS AGENTS OR EMPLOYEES SHALL CREATE A WARRANTY OR IN ANY WAY INCREASE THE SCOPE OF THIS WARRANTY.
- REPAIR OR REPLACEMENT AS PROVIDED UNDER THIS WARRANTY IS THE EXCLUSIVE REMEDY OF THE CONSUMER. THOMSON INC. SHALL NOT BE LIABLE FOR INCIDENTAL OR CONSEQUENTIAL DAMAGES RESULTING FROM THE USE OF THIS PRODUCT OR ARISING OUT OF ANY BREACH OF ANY EXPRESS OR IMPLIED WARRANTY ON THIS PRODUCT. THIS DISCLAIMER OF WARRANTIES AND LIMITED WARRANTY ARE GOVERNED BY THE LAWS OF THE STATE OF INDIANA. EXCEPT TO THE EXTENT PROHIBITED BY APPLICABLE LAW, ANY IMPLIED WARRANTY OF MERCHANTABILITY OR FITNESS FOR A PARTICULAR PURPOSE ON THIS PRODUCT IS LIMITED TO THE APPLICABLE WARRANTY PERIOD SET FORTH ABOVE.

How state law relates to warranty:

- Some states do not allow the exclusion nor limitation of incidental or consequential damages, or limitations on how long an implied warranty lasts, so the above limitations or exclusions may not apply to you.
- This warranty gives you specific legal rights, and you also may have other rights that vary from state to state.

Accessory Information

There are accessories available to complement your DVD Player. Prices are subject to change without notice. All accessories are subject to availability.

A shipping and handling fee will be charged upon ordering, and we are required by law to collect the appropriate sales tax for each individual state, country, and locality to which the merchandise is being sent.

How to Order

To place an order by phone, have your Visa, MasterCard, or Discover Card ready and call the toll-free number listed below.

1-800-338-0376 (Use this number only to place an order for accessory items.)

For more information about accessories, go to www.rca.com

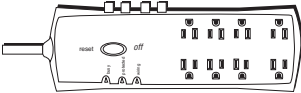

Surge Protector (SCTV4000C), 8 outlets, 2090 joules, \$100,000 Surge Equipment Guarantee, price \$49.95



Component Video to VPORT cable (GP650XB), price \$29.95



RF Modulator (CRF910). Used to connect DVD player to a TV that doesn't have Audio and Video jacks. Price \$29.95
CRF940 (not pictured) \$39.95



Remote Control part number 260607

Visit the RCA website at www.rca.com

Please do not send any products to the Indianapolis address listed below or on the carton. This will only add delays in service for your product.

Thomson Inc.

10330 North Meridian Street
Indianapolis, IN 46290

©2004 Thomson Inc.

Trademark(s) ® Registered

Marca(s) Registrada(s)

Printed in China

TOCOM I642I450



THOMSON

THOMSON 